

FIXEDRFID READER

# FR900

QUICK  
GUIDE



BLUEBIRD



# This user manual is protected by copyright.

---

Copyright © 2020 Bluebird Inc. All rights reserved.

Bluebird Inc. is the designer and manufacturer of Bluebird handheld mobiles.

This manual and the programs in this device are protected under international copyright laws, and may not be copied, distributed, translated, or removed by any means.

## Registered Trademark

---



BLUEBIRD is an emerging global brand, striving to lead the market in performance and mobility. Their products represent reliability, innovation, and innovative technology. Bluebird is a registered trademark from the global brand of Bluebird Inc. and is copyright protected.

- Bluebird and stylized Bluebird Logo are registered trademarks and symbols of Bluebird Inc.
- Adobe® is a registered trademark of Adobe Systems Inc.
- All other trademarks and copyrights are the property of their respective owners.

## User's Guidance

---

Device type	User's guidance
Class A Device	This device has qualified the electromagnetic wave suitable registration and can be used at business, industrial and commercial environment.
Type Registration	This wireless device may cause propagation interference, and so, it cannot be used for life-saving services.



## 1.1 Symbols

This manual uses the following symbols to indicate hazards and additional information.

Symbol	Name	Description
	Warning	Indicates situations that could cause injury to yourself or others.
	Caution	Indicates situations that could cause damage to your device or other equipment.
	Note	Indicates additional information that can help you get the most out of the device.



Please read this safety precaution information carefully. Failure to follow the information provided may result in fire, electric shock, or other property damage or bodily injuries.

## 1.2 Device



- Do not press the Power button on the device if the device is wet or do not touch adapter or power cord with wet hands. There is risk of electric shock.
- Do not use your device in an explosive danger zone.
- If your device becomes wet, do not put your device in heaters, microwaves, etc. to dry it. There is a risk of explosion or malfunction.



- Although this device is very sturdy, do not drop, hit, bend, or sit on it on purpose. It can be broken.
- Do not modify, take apart, or repair the device. Contact to your customer service center. Failure to do so will void your warranty.
- Do not attempt to modify your hardware or software. It may cause device malfunction and void your warranty.
- Backup the data and information from your device. Your data may be erased during repairs or upgrades.
- Do not paint your device. It can damage your screen or your device's exterior.
- Avoid using or storing this device at extreme temperatures. This device is designed to work at temperatures between -10°C and 50°C (14°F and 122°F), and humidity level between 5% and 95%.



## 1.3 Environment



- Do not use the device while driving or operating heavy machinery. Doing so may result in death or serious injury.
- Do not use the device in locations with combustible goods. Doing so may result in an explosion.



- Do not use the device in dusty or hot locations. Doing so may damage the device.
- Do not expose your device to direct sunlight such as on the dashboard of a car for extended periods of time.
- Do not use the device in humid locations. Doing so may damage the device and void the warranty.
- Do not keep the device close to air conditioner vents. Corrosion within the device may occur due to condensation from changes in temperature.
- Do not allow children to play with the device.

## 1.4 Frequency Interference



- The device emits an electromagnetic fields. It may interfere with your medical devices.
- Do not place credit cards, phone cards, bankbook, and tickets next to the device. The magnetic field of the device can damage their magnetic strips.



### 2.1 Package Contents

The package includes:

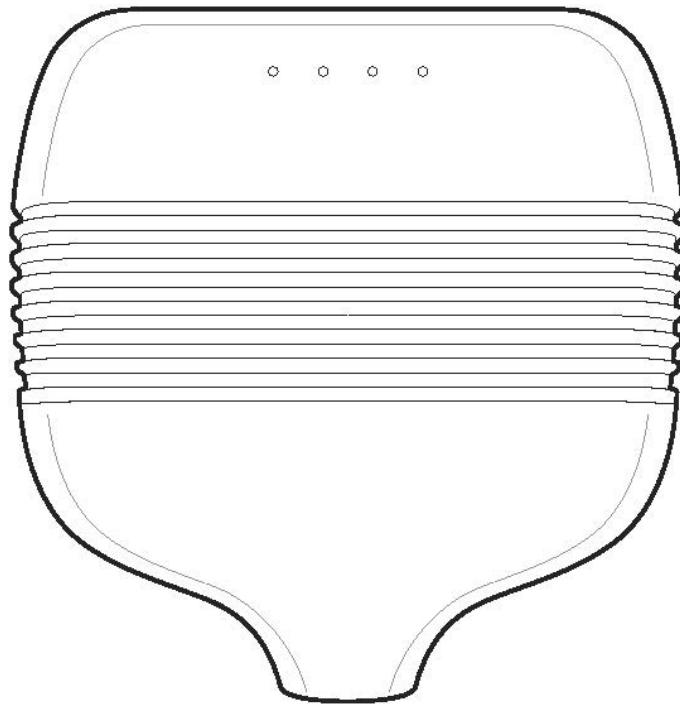

FR900 device



### 2.2 Your Device

#### 2.2.1 Front

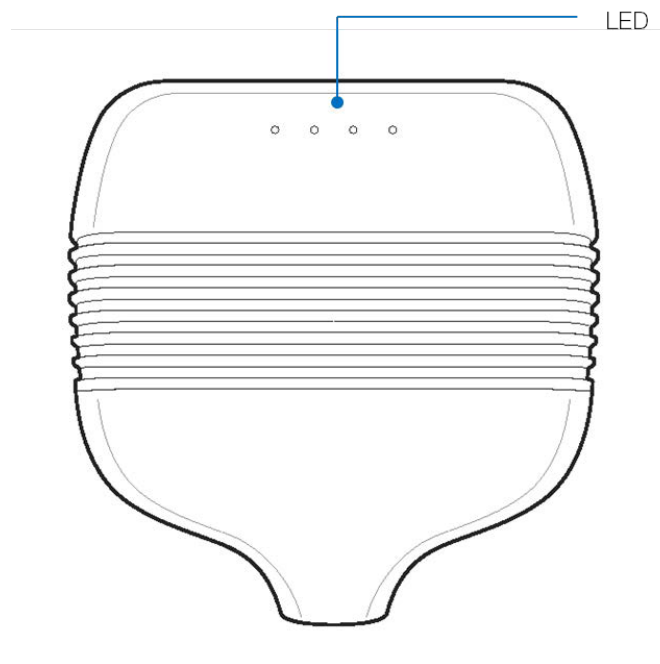

#### 2.2.2 Back

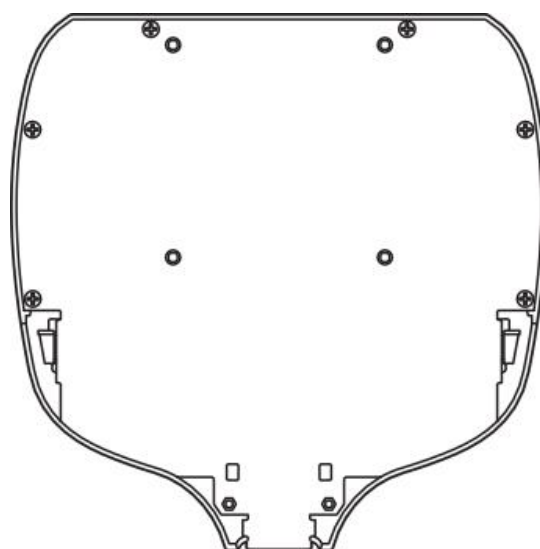



## 2.2.3 Bottom of Front

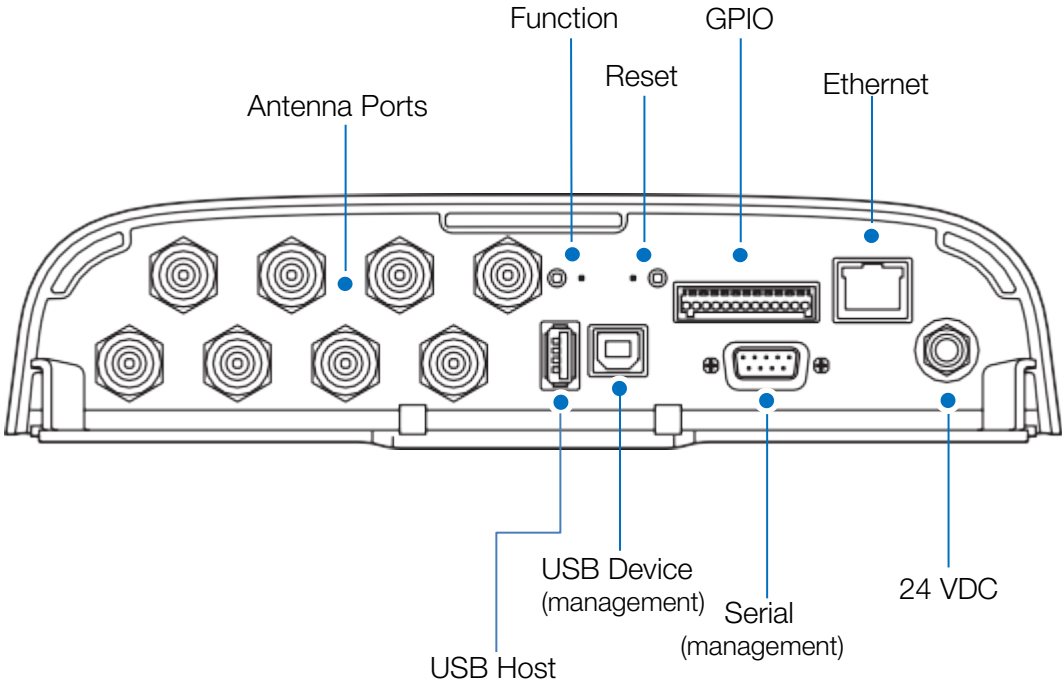
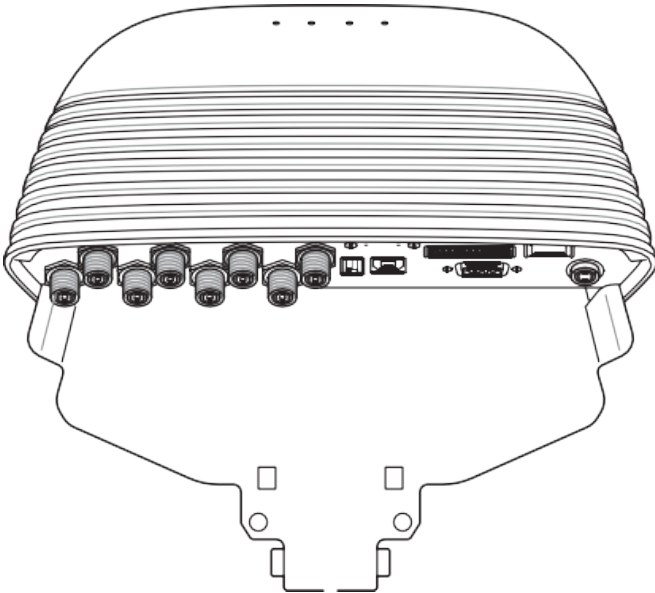

## 3 Installing and Connecting



This section provides details about FR900 I/O ports and status LEDs. It also explains how to install the Reader and connect it to your network

### 3.1 FR900 LED Status

Boot Complete Status

When the FR900 has finished booting, the ACTV-STAT-ERR LED will turn on three times in green.

LLRP Server Status :

Status	ACTV	STAT	ERR
Normal (not RFID Tagging)	-	GREEN	-
Initialize fail	-	RED	RED Blink
Connection or disconnection with client	-	GREEN Blink (2 times)	-
RFID Tagging	GREEN Blink	GREEN	-

Table 3.1 LLRP Server Status LED

Image Upgrade Status :

Status	ACTV	STAT	ERR
Image upgrade	GREEN	GREEN	-
Factory Reset	GREEN	RED	-

Table 3.2 Image upgrade Status LED

### 3.2 Installing and Connecting the Reader

The primary installation and connection steps for FR900 are:

- 1.Position the Reader appropriately for your environment.
- 2.Connect the antenna (s) to the appropriate ports on the Reader.
- 3.Connect power to the Reader.
- 4.Connect the Reader to the network.
- 5.Configure region setting on the Reader .
- 6.Test the Reader installation by reading tags.





### 3.3 Detailed Installation Procedures

This section provides the details for each installation and connection step.

#### 3.3.1 Step 1: Position the FR900 Reader and install the Reader.

Choose a suitable location for your Reader. The device should be placed away from direct sunlight, high humidity, extreme temperatures and sources of electromagnetic interference.

To power the reader using an external universal power supply, make sure the outlet is nearby.

#### 3.3.2 Step 2: Connect the Antenna(s) to the FR900 Reader

FR900 Reader has eight antenna ports. Each port is independent, bidirectional, and full duplex TX/RX (monostatic).

To connect the antenna(s) to the Reader:

1. Position each Reader antenna, keeping the following points in mind:
  - Position the antenna(s) to achieve the most effective and efficient tag reads.
  - Position the antenna(s) to maximize operator safety.
2. Mount the antenna(s) according to the instructions provided by the antenna manufacturer.
3. Attach the antenna cable(s) to the antenna port(s) on the Reader.
4. Finger-tighten each connection, making sure the connection is secure.

#### 3.3.3 Step 3: Power the Reader

External universal power supply

Connect the AC power plug into a suitable 100–240 VAC, 50–60 Hz power outlet.

The Power and Status LEDs on the Reader alert you to the status.

For more information, see section 3.1 FR900 Ports and LEDs.

#### 3.3.4 Step 4: Connect the FR900 Reader to the Network

You are now ready to connect the installed FR900 Reader to your network. You have two options:

- If your network supports DHCP, you can connect the Reader directly to your Ethernet network. After the Reader is powered, immediately communicate with it via SSH (TCP/IP).
- If your network does not support DHCP, or if you want to connect a PC directly to the Reader via Ethernet cable, the Reader defaults to the following fixed IP address: 169.254.1.1.

Setting	Description
Hostname	FR900-XX-XX-XX where XX-XX-XX is the last three bytes of the Reader's MAC address (which is printed on the version label attached to the Reader case).
DHCP	Default Enabled. The Reader also reports its hostname to the DHCP server. Note: When the reader is plugged into a network that doesn't have a DHCP server OR when the PC is connected directly to the Reader via Ethernet cable, the Reader defaults to a fixed IP address (169.254.1.1).

Table 3.3: Default Network Settings

## 3 Installing and Connecting



To connect the FR900 Reader to the Ethernet network

Using a standard Ethernet cable, connect the RJ-45 connector on the Reader to a LAN drop or network switch. A typical network configuration is shown in Figure 3.1.

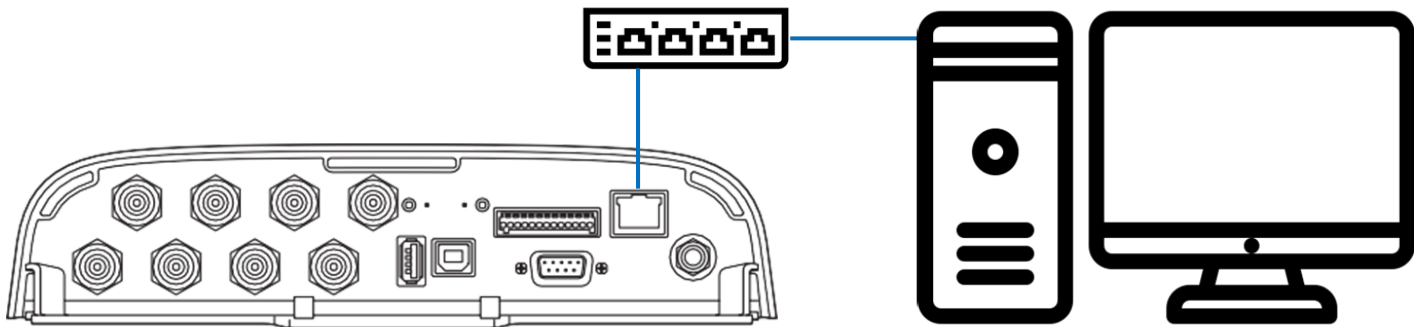

Figure 3.2 Connecting the FR900 Reader to the Ethernet Network

To connect a FR900 Reader to your PC over a usb connection

1. Confirm that you have the latest version of Putty, a free and reliable SSH, and serial client. Putty version 0.60 or later contains support for serial connections.
2. Use a USB A-B cable to connect your PC's usb port on the Reader, as shown in Figure 3.2

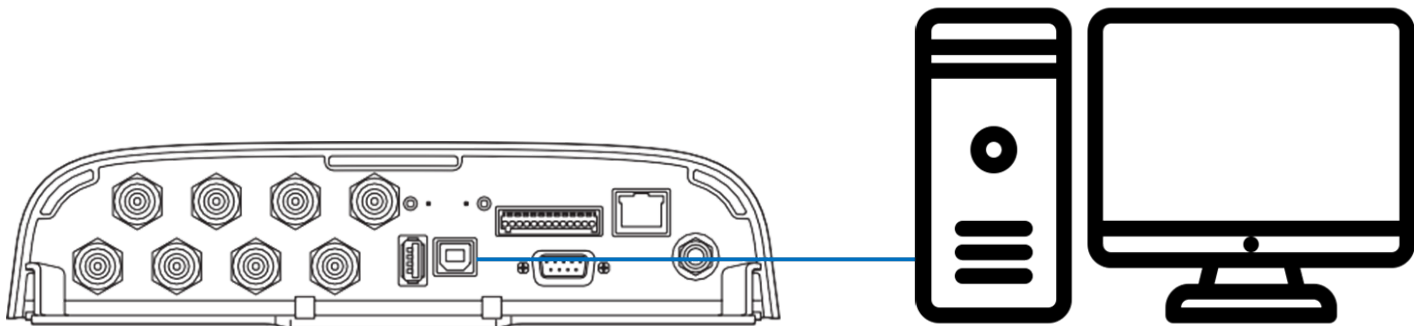

Figure 3.3 FR900 USB Connection (management)

3. Power up the Reader and wait for the boot sequence to complete.
4. On the PC, run the Putty application and select the Serial connection option.
5. On the Putty Configuration dialog, shown in Figure 3.3, verify that Serial line to connect to is set to COMX
6. Set Speed to 115200.
7. Set Flow control to None, and then click Open.

## 3 Installing and Connecting

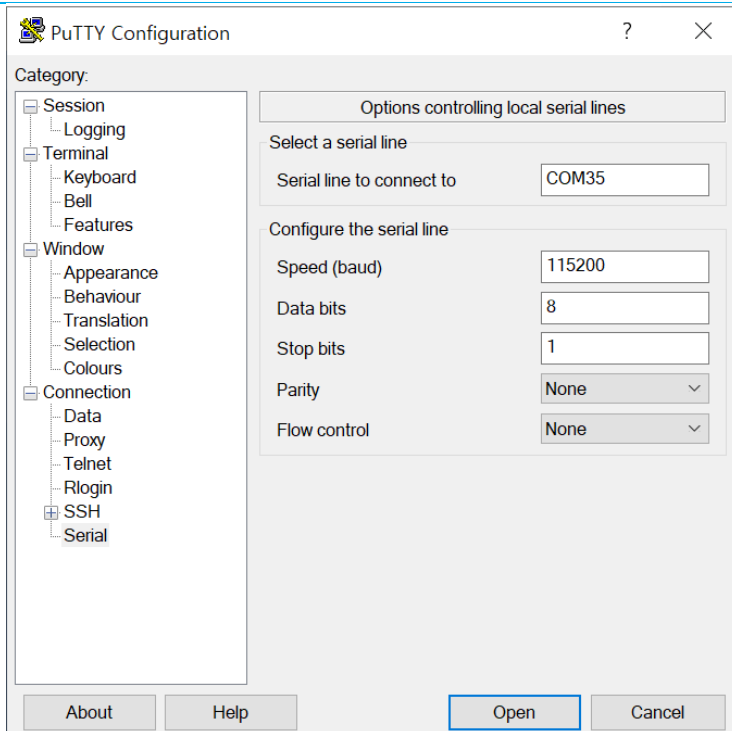

Figure 3.4 Putty Configuration Settings

8. At the BB Shell login prompt shown in Figure 3.4, log in with the Default password.
- user name: root
  - password: bluebird



Figure 3.5 BB Shell login prompt

9. When the BB Shell command-line prompt displays, begin configuring the network settings for the Reader. For more information, see Section 4.1.1 Using BB Shell to Configure Network Settings for FR900.
10. When you have completed configuration of the appropriate network settings, connect the Reader to your Ethernet network.

## 3 Installing and Connecting



### 3.3.5 Step 5: Configure the Region Setting

Configure the region if necessary. The region can be configured using the config system region command in the BB Shell.

Note that FCC, ETSI, Japan, and Australia Readers cannot be altered and only operate per the regulatory laws in USA/Canada, the European Union, Japan, and Australia.

Command1	Descriptions
region	Configure the region of Reader. ASCII characters are allowed. You must use capital letters. You can only configure the region defined in the region table.

The config system region command allows the user to configure Reader's region. ASCII characters are allowed. You must use capital letters. You can only configure the region defined in the region table.

0	KOREA	9	INDIA	18	NEW_ZEALAND	27	VENEZUELA
1	ETSI	10	INDONESIA	19	PAKISTAN	28	VIETNAM
2	FCC	11	IRAN	20	PERU	29	RUSSIA
3	AUSTRALIA	12	ISRAEL	21	PHILIPPINES	30	ALGERIA
4	BANGLADESH	13	JAPAN_1	22	SINGAPORE	31	EGYPT
5	BRAZIL	14	JAPAN_2	23	SOUTH_AFRICA	32	CHILE
6	BRUNEI	15	JORDAN	24	TAIWAN		
7	CHINA	16	MALAYSIA	25	THAILAND		
8	HONGKONG	17	MOROCCO	26	URUGUAY		

Table 3.1 region table

Example :

```
[FR900] config system $ region Korea  
Return='0,Success'
```

### 3.3.6 Step 6: Test the Reader

Read the tag and verify that the connections and functions are correct. DemoApp, BLUEBIRD's Windows PC test application, makes it easy to check Reader operation. Use DemoApp to configure various settings and then run a simple inventory operatio



This section provides a high-level overview of the configuration and monitoring options available for FR900 Reader

### 4.1 Configuring FR900 Reader

You can think of FR900 Reader configuration in two categories: configuring the device itself and configuring the Reader's RF behavior. This section provides the basics for each type of configuration.

#### 4.1.1 Device Configuration

BB Shell is a proprietary command-line management interface used to configure and manage network settings, firmware upgrades, and other device-oriented operations. This section introduces the BB Shell commands to use to install and connect the Reader. The BB Shell Reference Manual provides full details and syntax for all BB Shell commands.

The following procedure outlines the BB Shell commands you might need to connect the Reader to your network.

1. Open the BB Shell console.
2. View the Reader's current configuration settings by entering the show network summary command at the BB Shell command prompt as shown in the following example:

```
> show network summary
  Hostname:FR900-96-69-23
  IP addr Mode:static
  IP addr:192.168.50.115
  Bcast:0.0.0.0
  Mask:255.255.255.0
  Gateway:192.168.50.1
  Return='0,Success'
```

3. Configure the appropriate TCP/IP parameters for your environment. The applicable commands are:  
Setting Hostname

```
> config network hostname <HOSTNAME>
```

Setting Static IP Address

```
> config network ip static <IP ADDRESS> <NETMASK> <GATEWAY>
```

Note: The IP address is required, however the other parameters are optional. The default value is used if an optional parameter is omitted from the ip command.

Note: The reader MUST be rebooted for this command to take effect.

Enabling DHCP

```
> config network ip dhcp
```

Configuring NTP Servers

```
> config network ntp add <NTP SERVER ADDRESS>
```

4. After successfully configuring all required network settings, connect the Reader to the network through the FR900 Ethernet port.



## 4.1.2 RF Configuration

FR900\_SDK\_DEMOAPP is an example of a PC client application.

Regardless of the application you're using, the underlying protocol is the same, Low-Level Reader Protocol (LLRP).

LLRP is a standard, asymmetric, binary protocol used for communication between a client application and the Reader. LLRP controls the configuration of the antenna transmit power, the receive sensitivity, the operating Reader, and more. For more information about LLRP, see the following documents:

- LLRP Standard This document provides the specifics of the LLRP standard ratified by EPCglobal. [http://www.epcglobalinc.org/standards/llrp/llrp\\_1\\_0\\_1-standard-20070813.pdf](http://www.epcglobalinc.org/standards/llrp/llrp_1_0_1-standard-20070813.pdf)

### Using DemoApp to Configure and Test FR900

BLUEBIRD provides a LLRP application to use to configure and test the basic RF behavior of FR900. The DemoApp is available from the BLUEBIRD support Web site . To use DemoApp, your computer must be running a minimum of Windows 7 and have .NET Framework 4.6.1 installed.

This section describes how to connect to and configure a Reader's RF parameters by using DemoApp. It also provides a high-level description of each parameter.

To configure and test a Reader by using DemoApp

1. Launch the Demo App. The screen shown in Figure 4.1 displays.

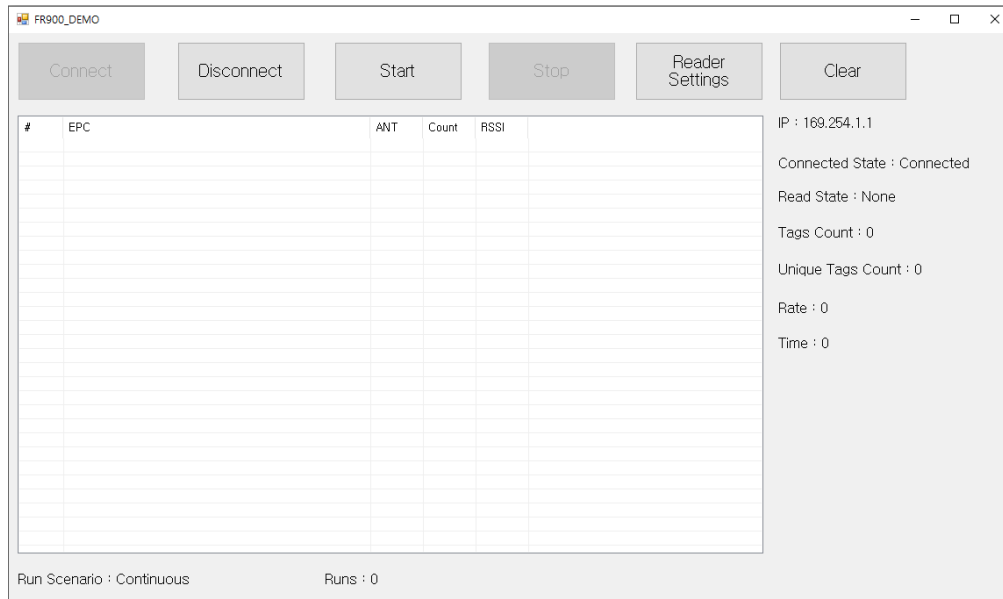

Figure 4.1 DemoApp initial screen

# 4 Configuring and Monitoring



2. Click Reader Settings. The Reader Settings screen displays

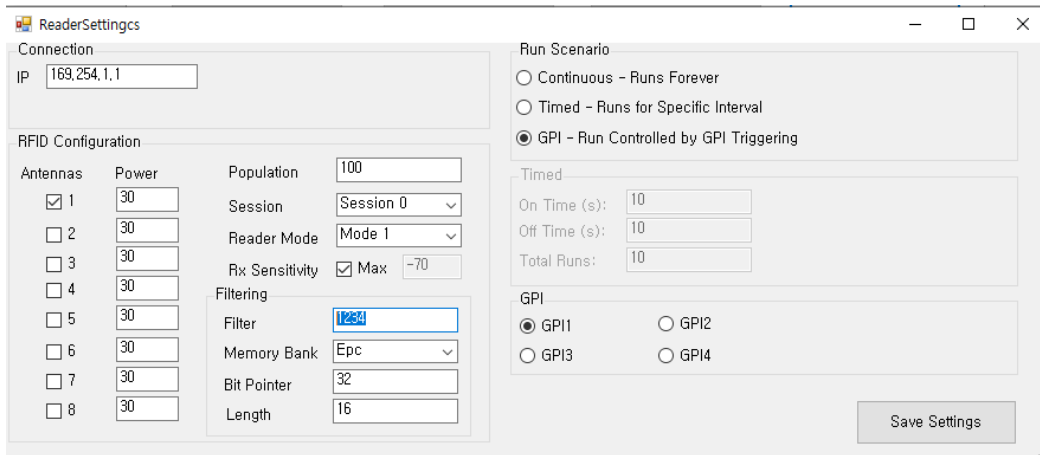

Figure 4.2 Demo App Reader Settings Connection Screen

**IP** : Enter the IP or hostname of the FR900

Note: You can find out the name and the IP address by using the BB Shell show network summary command. The show network summary command provides the dynamic values that are returned by DHCP or LLA if the current configuration is dynamic. The local hostname resolution feature (mDNS) gives the Reader a local hostname in addition to an IP address as its network identity. On an isolated network that lacks DNS service but that has mDNS enabled, a Reader with hostname FR900-A1-B2-C3, for example, can be reached using FR900-A1-B2-C3.local.

**Reader Mode** : Specifies the rules to use for communication between the Reader and the tag.

- Default : Mode 1
- Fastest : Mode 3

**Session** : To control when and how often the Reader reads a tag. Each tag contains a flag that is flipped from A to B or from B to A when it is read. The Session value controls how long the flag retains its value before reverting back to the original tag value. Search Mode controls which flag values the Reader reads and, in some cases, what happens to the flag value after the tag is read.

When you set Session to Dual Target, the Reader reads all the tags that have A flags.

Then, after reading the tags, the Reader flips each tag to B. When there are no more A tags to read, the Reader reads all the B tags, flipping each one to A after it has been read. It continues this process back and forth from A to B and back to A. Session 1 ensures that there is a persistence period that prevents tags from reverting before they have all been read.

- Session 0 (Auto Toggle On) : Continue reading the same tag
- Session 1 (Auto Toggle On) : The same tag is read every 0.5 ~ 1 second
- Session 2 or 3 (Auto Toggle On) : The same tag reads only once

**Population** : 1 to 65535 can be set. Set to 100 if there are 100 tags in front of the antenna.

**Rx Sensitivity** : Max or -70 ~ -30

Rx limit (RSSI) If set to -50db, RSSI below -50db will not be read.

**Filter** : If set to 1234, only EPCs starting with 1234 are read

**Memory Bank** : Reserved , EPC, TID, User (Usually use EPC)

**Bit Pointer** : Memory offset (bit) at filter, 32bit offset for EPC, 0bit for rest

**Length** : Double the length of the filter text



### Run Scenario

- Continuous : Press start button to start, continue reading until stop button is pressed
- Timed : Press start button to repeat start / stop every set time.

On time : Reading Time

Off time : Stop Time

Total Run : Repeat count

If set as below, it stops automatically after 10 times of 10 seconds Read-10 seconds stop.

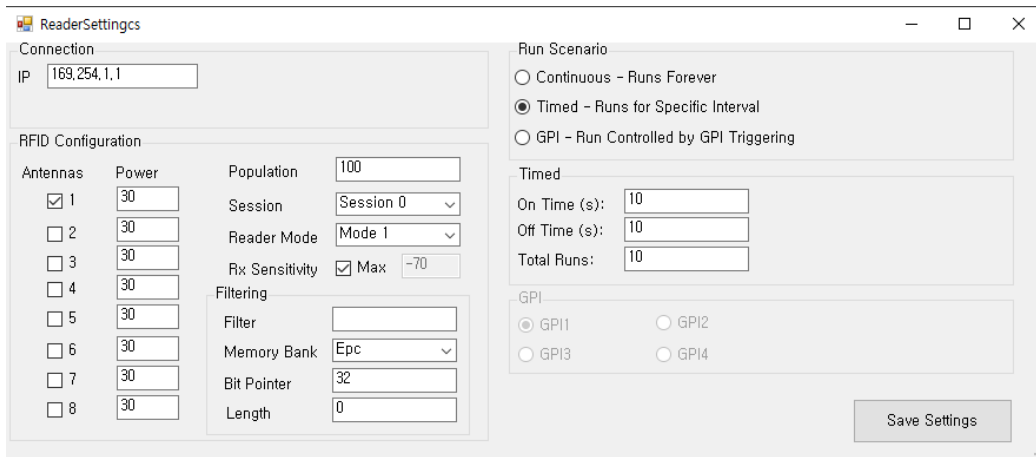

Figure 4.3 Demo App Reader Settings Time mode

- GPI : Press the Start button to start reading when GPIX is high and to stop reading when it is low. Set when using sensor.

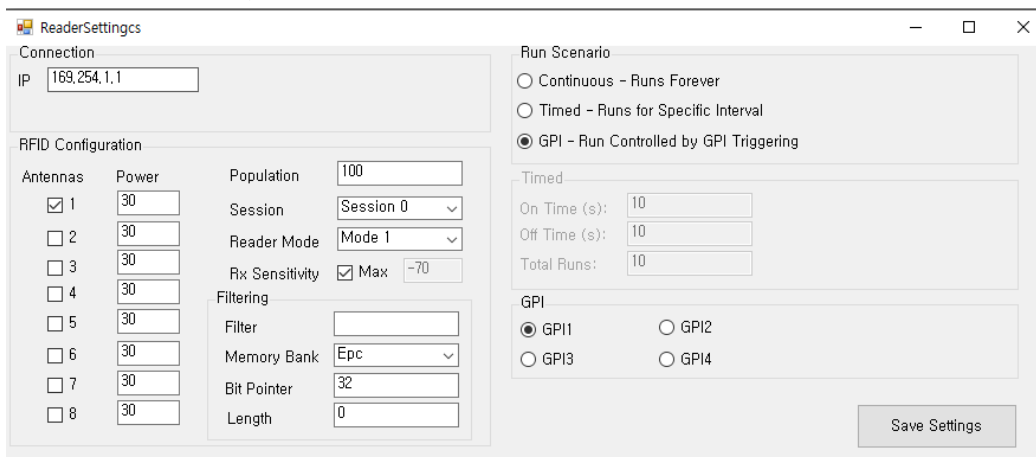

Figure 4.4 Demo App Reader Settings GPI mode

**Antenna Port & Power** : Power can be set for each antenna.

- Antenna Port : 1~8
- Antenna Power : 0 ~ 30

The optimal setting depends on many things:

- how you are powering the Reader
- length of the cable that connects the antenna to the Reader
- number of antennas in the area
- distance anticipated between the antenna and the tags

Use the default value of 30 dBm for testing purposes.



## 4 Configuring and Monitoring



3. Test your Reader installation. Place one or more tags in the read-zone of one or more of the attached antennas. On the DemoApp screen, click Connection and Start. Tag reads appear under Inventory, as shown in Figure 4.5.

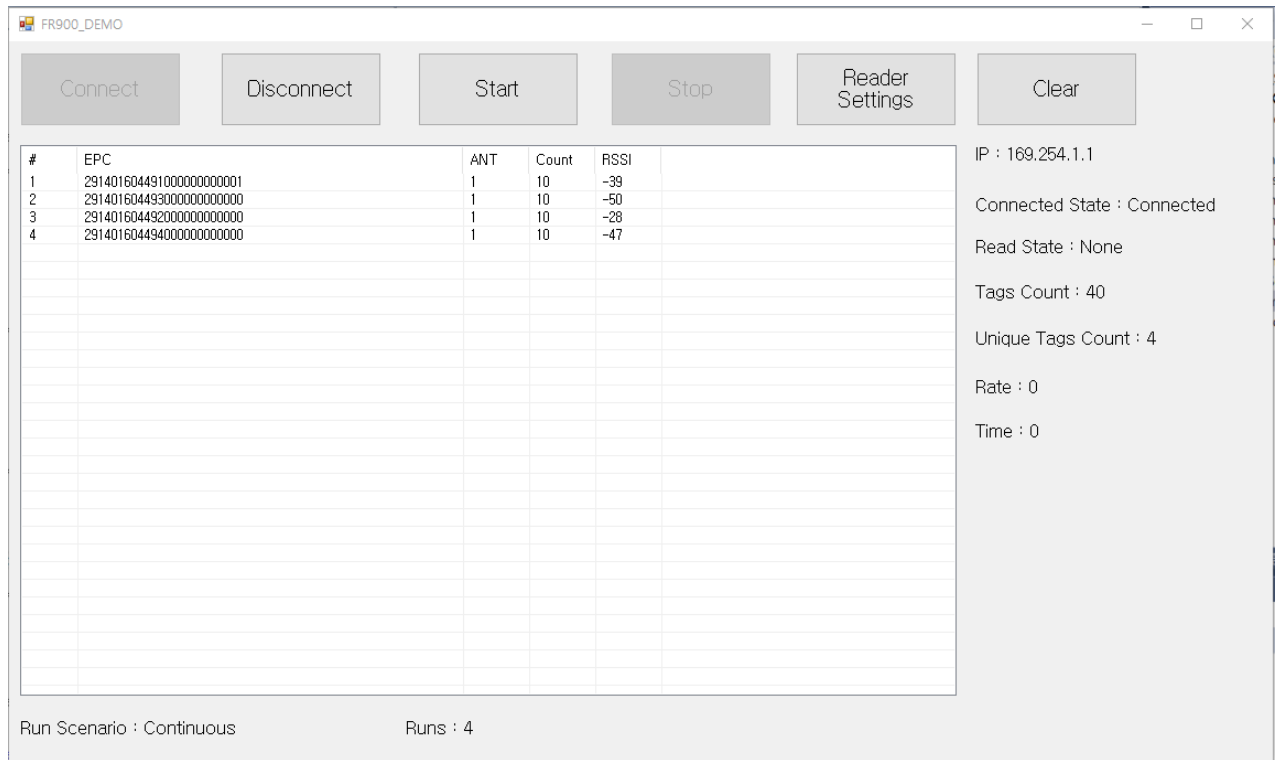

**Figure 4.5 DemoApp Reader Settings Connection and Start**

- Inventory Start / Stop
- You can check the total tag count, unique tag count, rate, and reading time.
- You can check EPC information, Antenna and RSSI.



### 4.2 Monitoring FR900

Use BB Shell to monitor the health and performance of the Reader when FR900 is up and running.

This section presents the primary BB Shell commands to use for viewing network and RFID statistics, in addition to the Reader logs. For more information about these commands, see the BB Shell Reference Manual

#### 4.2.1 Viewing Network Parameters and Statistics

Use the BB Shell show network command to display networking parameters and statistics. When you use this command with the parameters shown in Table 4.1, you can see the following information:

Command	Descriptions
summary	Display summary of network settings
hostname	Display hostname
dns	Display stored DNS Server list.
ip	Display IP address
mdns	Display the current state of mdns service
ntp	Display stored ntp Server list and current state.
http	Display the current state of http service.
ssh	Display the current state of ssh service
ftp	Display the current state of ftp service

Table 4.1 BB Shell Monitoring Command

#### 4.2.2 Viewing the State of the FR900 Reader

To display information about the current state of the Reader itself, use the BB Shell show system command. When you use this command, you can see the following statistics:

Command	Descriptions
summary	Displays a summary of system info
CPU	Displays CPU information, OS version information, memory and storage usage.
region	Displays current region and available region

Table 4.2 BB Shell Monitoring System Command



## Physical Characteristics

Dimension	253 x 254 x 56 mm
Weight	1.5 kg
Visual Status Indicators	Multicolor LEDs : Power, Activity, Status, Fault, Ant 4-8

## RFID Characteristics

Max Receive Sensitivity	-84 dBm monostatic
Return Loss (Min)	10dB
Air Protocols	ISO 18000-63 (EPC Class 1 Gen 2 V2)
Frequency (UHF Band)	US: 902-928 MHz EU: 865-868 MHz JP1: 916-921 MHz, JP2: 916~923 MHz CN: 920.5-924.5 MHz Russian Federation: 866-868 MHz
Transmit Power Output	US : 6 dBm to +36 dBm (EIRP) at the antenna EU : 3 dBm to +33 dBm(ERP) at the antenna configurable in 1 dB steps (Max radiated power at antenna should be lower than 4W EIRP for US/Canada and 2W ERP for EU)

## Environmental

Operating Temp	-20° to +55° C / -4° to +131° F
Storage Temp	-40° to +85° C / -40° to +185° F
Humidity	5-95% non-condensing
Sealing	IP53
Shock/Vibration	MIL-STD-810G

## Performance Characteristic

Processor	600 MHz Processor
Memory	256 MB RAM / 512 MB Flash
Operating System	Linux



### Connectivity

Communications	10/100 BaseT Ethernet; USB Host & Client (Type A & B),(Type B: management) DB9 1ea(management), RJ-45 1ea, HW Reset button, Function button (Optional) Wi-Fi and Bluetooth via dongle adapter
General Purpose I/O	4 inputs, 4 outputs optically isolated (Terminal Block)
Power Supply	POE(15.4W)/ POE+(30W) + 24V DC Universal Power Supply
Antenna Ports	8 monostatic ports (Reverse Polarity TNC) circular or linear polarization; near and far field compatible



Please ask your sales representative for the specifications not listed above or for the future upgradeable specifications

## 6 Troubleshooting

---



### **I dropped the device in the water.**

Turn off the device. Place the device in a dry place. Let it dry completely for a considerable period of time, and then turn the device back on. If it does not turn back on, contact our service center.

### **My device gets too hot to touch.**

It is normal for the device to warm up while it is receiving a poor signal, performing an intense workload, It should cool down if you stop using the device for a certain amount of time. If the problem continues, contact the manufacturer. It may result in fire.

### **How do I get the repair service?**

You can contact your local sales representative or you can send the device via a delivery service to Bluebird's Korean headquarters. When sending the package, make sure you pay for the shipping fee in advance. When the repair is finished, Bluebird will cover the shipping cost.



## Customer support

Before asking for after-sales service, please back up the data on the device. We do not back up data from the products sent to the Customer Service Center. Therefore, we assume no responsibility for loss/deletion of data.

### Customer Service Center

#1103, Gplus Kolon Digital Tower 11F,  
Digital-ro 26-gil 123, Guro-gu, Seoul, Republic of Korea(08390)

- Fax: +82-2-6499-2242
- Email: rma@bluebirdcorp.com
- Hours: 9:30 a.m. - 6:30 p.m. (GMT Time: +9 Hours)



The center is closed on Saturdays, Sundays, and Korean national holidays.

### Registering for After-Sales Service

- We receive the products for our after-sales service through mail, delivery services and hand delivery only in principle.
- If you bought the product from a party other than Bluebird or an authorized Bluebird reseller, you need to register the product before using our after-sales service.
- Please enclose an evidence of purchase or the product receipt for our after-sales service.
- Please enclose your name, telephone number, address and details of the problem for a prompt service.
- You can ask for our after-sales service by contacting your authorized Bluebird dealer or the Customer Service Center in the head office.
- Do not intentionally damage the label on the product.
- A damaged label may result in a disadvantage to the customer.
- When you return the product to Bluebird for service, please put the product in a protective box.
- The warranty will not cover any damage which occurs during delivery. We advise you to use the box and protective cover supplied with the product.
- Make sure to deliver the product in a safe way. Bluebird assumes no responsibility for the loss of the product during delivery.



### Charged services

- In the following cases, it will be charged when requesting for after-sales service.
  - Service request due to inappropriate use of the device by the customer
  - Use of programs that might affect the program (over-clock, forceful changes in the input of the system, personal developments)
- Faults caused by the customer.
  - Defect due to inappropriate or careless use of the product (dropping, submersion under water, shock, damage, unreasonable operations, etc.)
  - Defect due to a repair or unauthorized technician
  - Defect caused intentionally or by the carelessness of the customer
  - Defect due to the use of fraudulent parts or components
- Other cases
  - Defect due to nature (damage caused by fire, wind, flooding, etc.)
  - Accessories are out of warranty (accessories like cable/adapter, etc. have a warranty of 6 months)
- Regulations for repairs after charged services
  - If the same fault occurs in the part that has been repaired within a 1 month (30 days), the part will be repaired free of charge.



No refunds will be offered in the following situations:

- The product seal has been removed (if applicable).
- The product has been damaged due to careless use by the customer or due to a natural disaster (floods, rain, fire, etc.).
- Loss of product or other components (manual, connecting cables, etc).
- DOA (Dead on Arrival) policy  
If your product is DOA (Dead on Arrival), or has malfunction within 30 days of purchase (DOA period), the product will either be exchanged or provided with after-sales service.



## Warranty certificate

Thank you for purchasing a product from Bluebird Inc.

- In case of accessories, only those that match the sales list managed by the Customer Service Center will be eligible for customer service.

Name of Product	Fixed RFID Reader
Name of Model	FR900
Date of Purchase	
Manufacture Number	
Place of Purchase	
Term of Guarantee	1 year from purchase

## Warranty information

- Bluebird Inc. (hereinafter referred to as Bluebird) provides the warranty service for its products in compliance with the Bluebird's warranty program.
- Upon receiving a notification on a defect of its product within the range of warranty during the warranty period, Bluebird will repair or replace the defective product according to its warranty policy.
- If the defective product within the range of warranty is not repairable or replaceable, Bluebird shall refund the purchasing price within a designated period from the date of receiving a notice of defect.
- Bluebird assumes no responsibility for repairing, replacement or refund until it receives the defective product from the customer. The replacement shall be equivalent to a new product in the aspect of performance.
- Bluebird products may contain the recycled products, components or materials equivalent to new products in the aspect of performance.
- This warranty is applied to software products only when the programming commands are not executed. Bluebird does not guarantee interruption-free or error-free performance.



## 7 Warranty and Support

---



This device complies with part 15 of the FCC Rules. Operation is subject to the following two conditions:

- (1) This device may not cause harmful interference, and
- (2) This device must accept any interference received, including interference that may cause undesired operation.

The User's Manual or User's Manual for the intentional or unintentional radiator warns the user that a change or change that is not explicitly approved by the party responsible for compliance may invalidate the user's authority to operate the equipment. If the manual is provided in a form other than paper, such as through a computer disk or the Internet, the information required by this section may be included in the documentation, provided that it is reasonably possible to expect users to have access to that type of information.

15B : NOTE: This equipment has been tested and found to comply with the limits for a Class B digital device, pursuant to part 15 of the FCC Rules. These limits are designed to provide reasonable protection against harmful interference when the equipment is operated in a commercial environment. This equipment generates, uses, and can radiate radio frequency energy and, if not installed and used in accordance with the instruction manual, may cause harmful interference to radio communications. Operation of this equipment in a residential area is likely to cause harmful interference in which case the user will be required to correct the interference at his own expense.



**BLUEBIRD**

**BLUEBIRD CUSTOMER SERVICE**

**Operating Hours**

Monday to Friday 9:30 A.M. - 6:30 P.M.  
(GMT Time: +9 Hours)  
The center is closed on Saturdays,  
Sundays, and Korean national holidays.

**Customer Service Center**

#1103, Gplus Kolon Digital Tower 11F,  
Digital-ro 26-gil 123, Guro-gu, Seoul,  
Republic of Korea(08390)

Bluebird constantly strives to bring utmost satisfaction to all our customers.